



WIZARD

• VACUUM PRECISION PLANTERS •

WZ-D ASSEMBLY INSTRUCTIONS



WZ-D

STEP 1

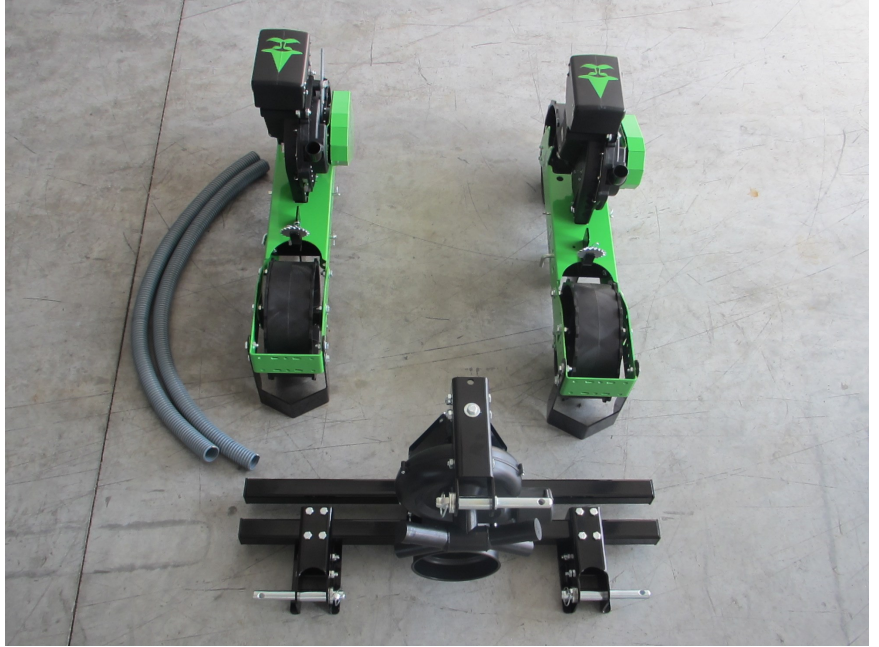

STEP 2

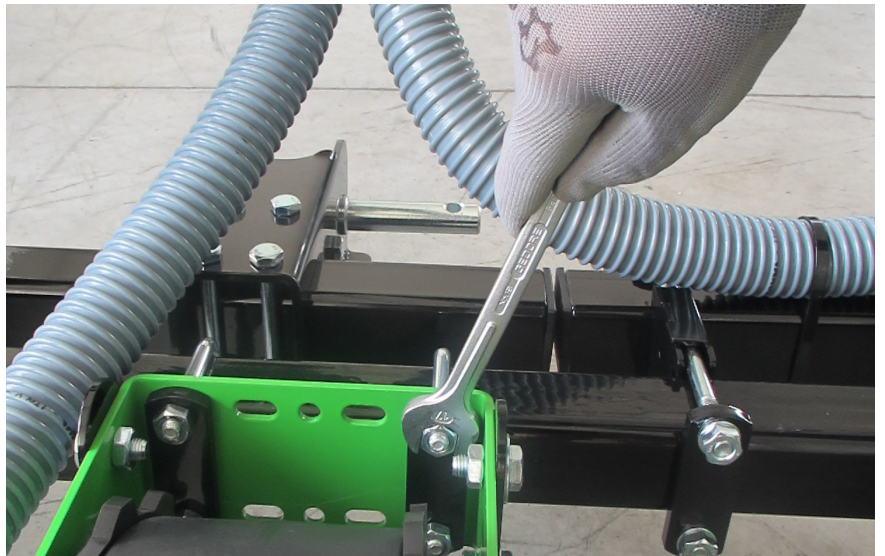

STEP 3

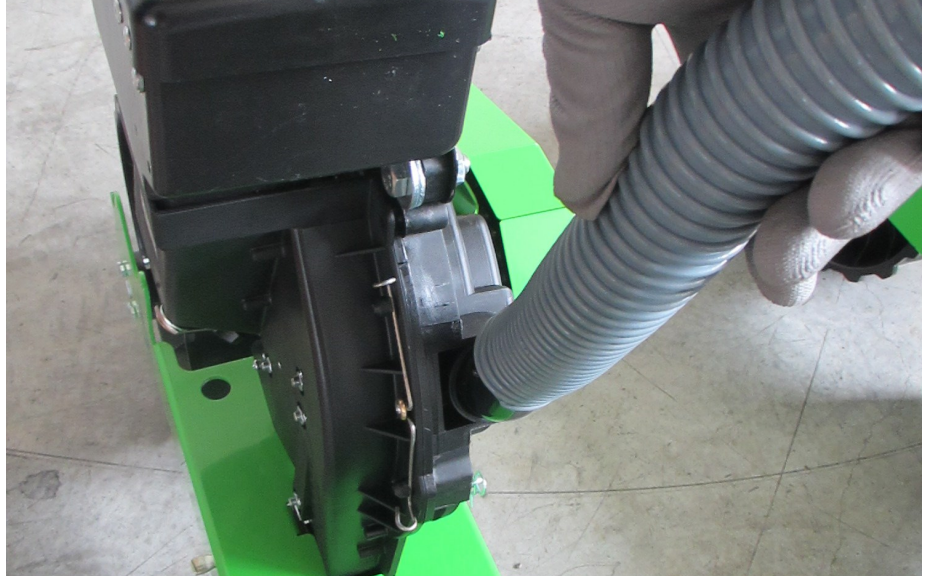

STEP 4

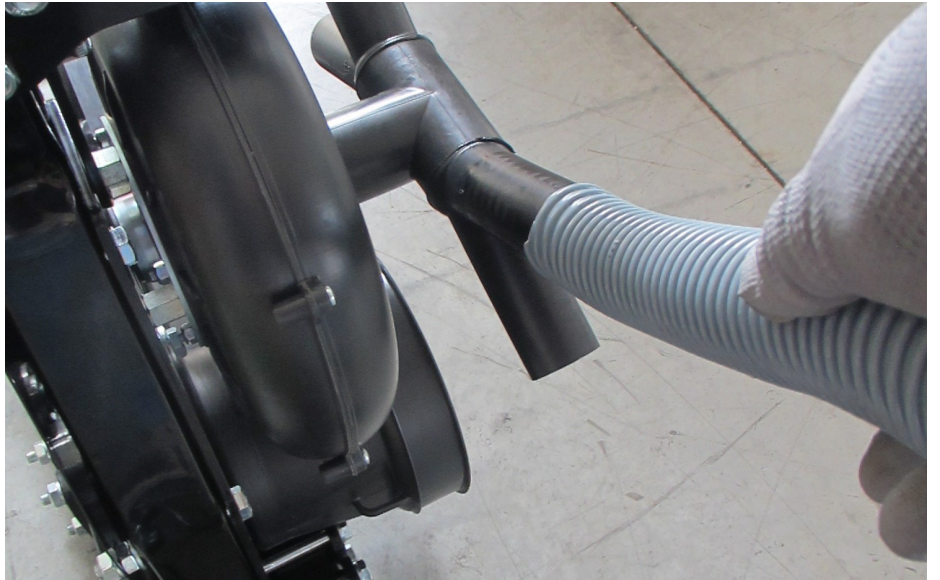

STEP 5



WZ-D 2500mm

STEP 1



STEP 2



STEP 3

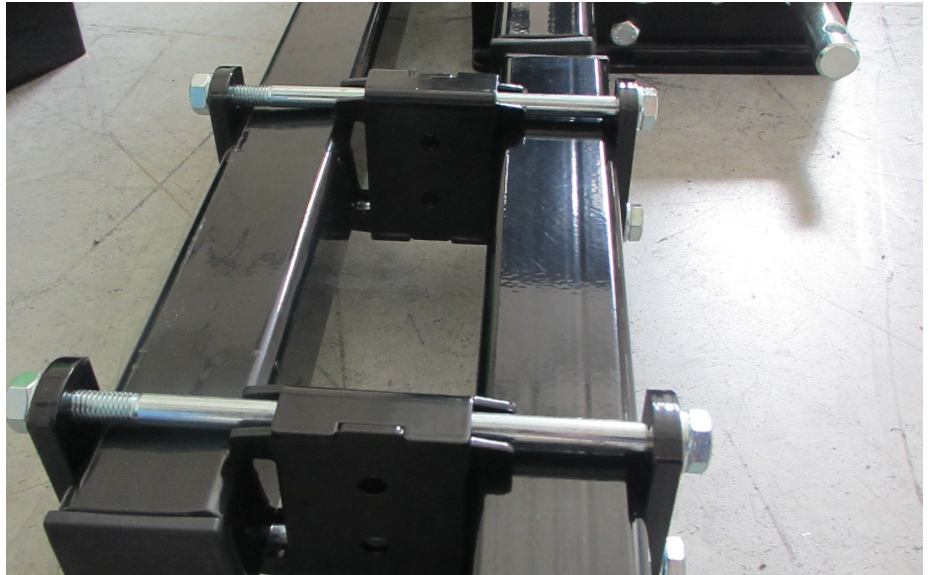

STEP 4

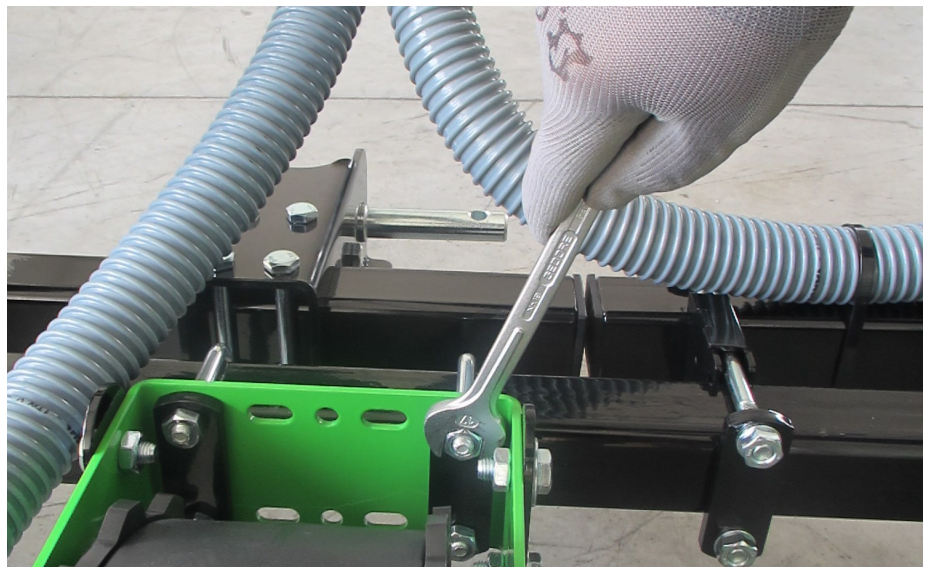

STEP 5

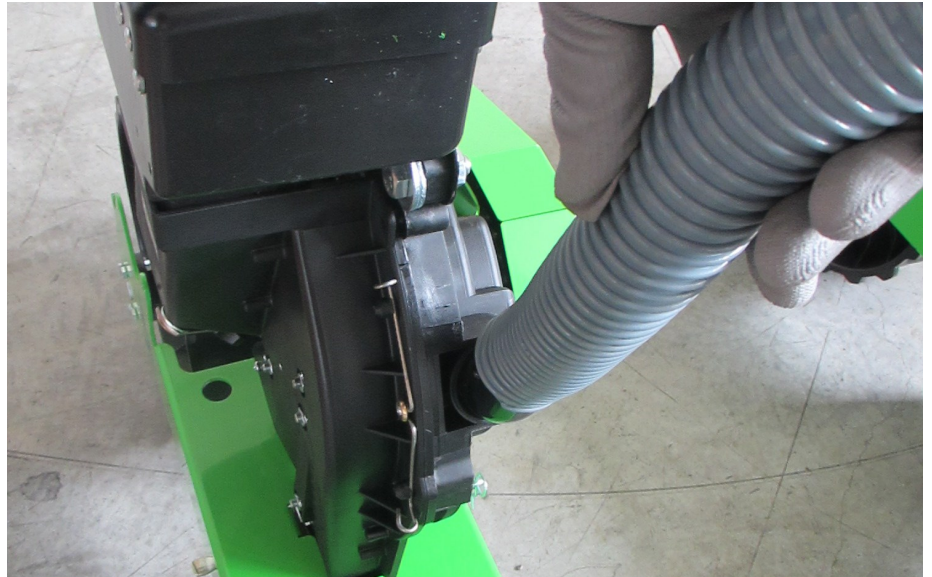

STEP 6

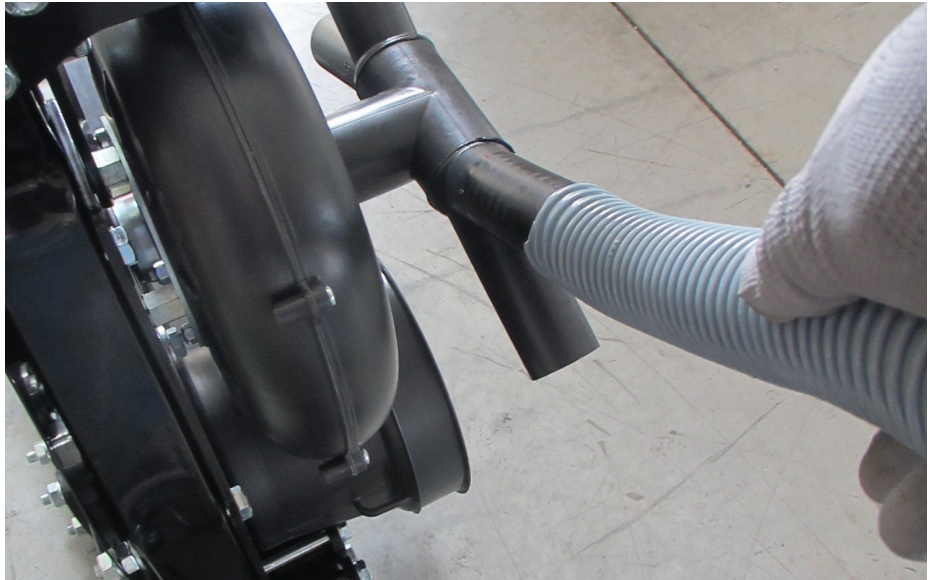

STEP 7





WIZARD

WZ-D

CATALOGO RICAMBI - SPARE PARTS CATALOG - CATALOGUE PIÈCES DE RECHANG -
ERSATZTEIL KATALOG - CATALOGO DE REPUESTOS

SERIE 00003

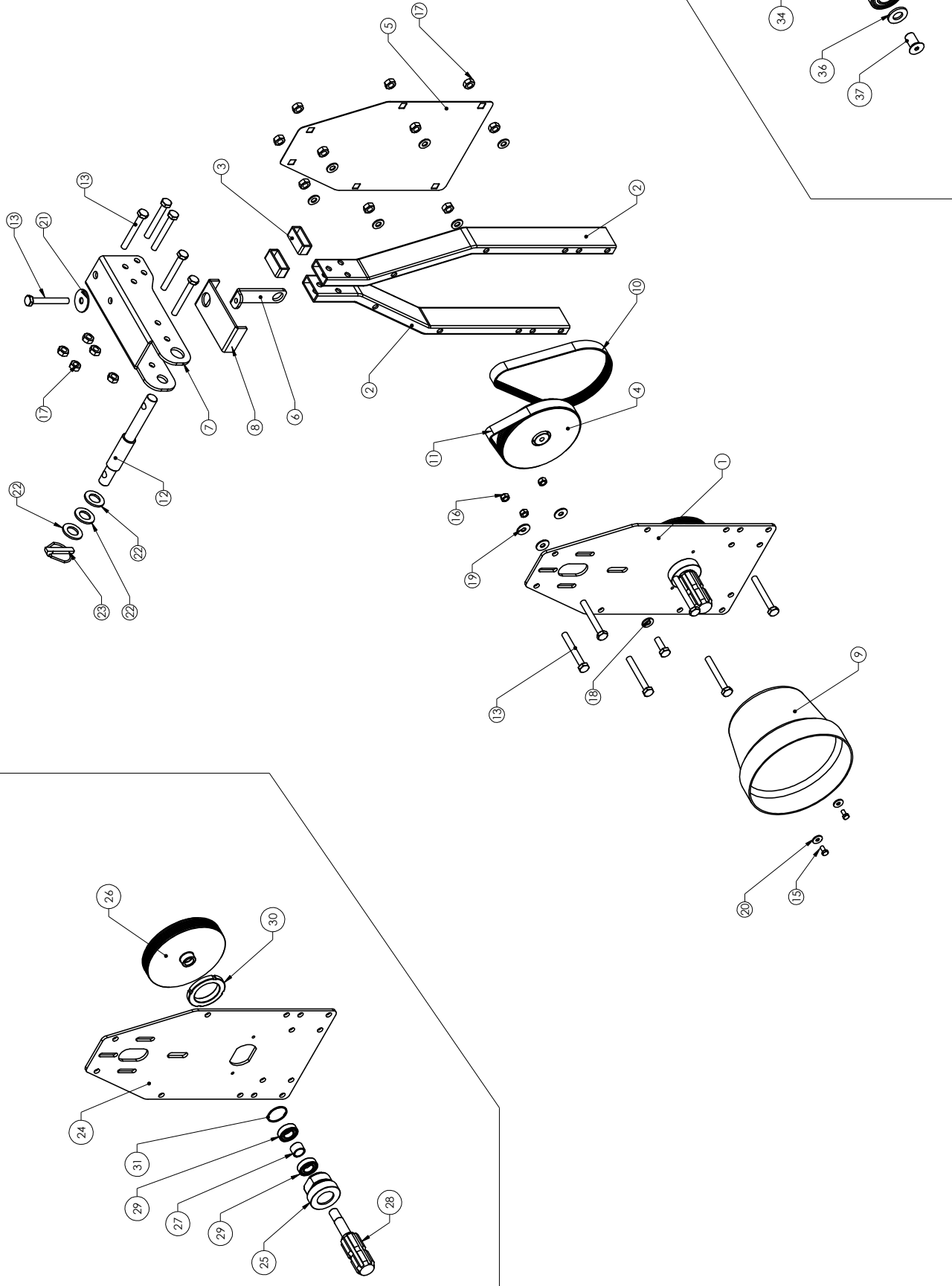
1**4**



ATTACCO TRATTORE

RC-400-001

Rev. 00

RIF.	DESCRIZIONE	CODICE	4 (100-00-A0Q-00004)
1	ASSIEME PERNO PER ATTACCO TRASMISSIONE TRE PUNTI	100-00-A0Q-00002	32 ALBERO PULEGGIA 100-00-P0B-00198
2	SOSTEGNO TERZO PUNTO	100-00-P0B-00202	33 DOPIA PULEGGIA POLY-V 8 GOLE (TIPO "J") Øe150-Øe46 100-00-P0B-00197
3	DISTANZIALE	100-00-P0B-00203	34 BOCCOLA CIL Øe22.0 Øi17.1 L=20.2 100-00-P0B-00045
4	ASSIEME DOPIA PULEGGIA	100-00-A0Q-00003	35 CUSCINETTO 6003-2RS C3 999-00-CAC-00003
5	CARTER PROTEZIONE	100-00-P0A-00083	36 RONDELLA PIANA 10,5x21 ZN UNI 6592 999-00-C0C-10010
6	TENDICINGHIA	100-00-P0A-00084	37 VITE TPS CON CAVA ESAGONALE M10x20 - 8.8 ZN UNI 5933 999-00-C0A-51020
7	LAMIERA ATTACCO TERZO PUNTO	100-00-P0A-00091	
8	RINFORZO ATTACCO TERZO PUNTO	100-00-P0A-00092	
9	CONTROCUFFIA TONDA MEDIA IN PLASTICA RIGIDA Ø 200, LUNGHEZZA 150 mm	999-00-CAI-00002	
10	CINGHIA POLY-V 8 GOLE Tipo "J" L=610	999-00-C0D-00010	
11	CINGHIA POLY-V 8 GOLE Tipo "J" L=508	999-00-C0D-00009	
12	PERNO DOPIO ATTACCO A TREZZI 3° PUNTO CAT.1°-CAT.2°	999-00-C0O-01925	
13	VITE TE M10x80 - 8.8 ZN UNI 5739	999-00-C0A-21080	
14	VITE TE M10x30 - 8.8 ZN UNI 5739	999-00-C0A-21030	
15	VITE TE M6x12 - 8.8 ZN UNI 5739	999-00-C0A-20612	
16	DADO ESAGONALE AUTOBLOCCANTE M8 ZN DIN 980	999-00-C0B-60008	
17	DADO ESAGONALE M10 ZN UNI 5588	999-00-C0B-10010	
18	RONDELLA PIANA 10,5x21 ZN UNI 6592	999-00-C0C-10010	
19	RONDELLA PIANA A FASCIA LARGA 9x24 UNI 6593	999-00-C0C-20924	
20	RONDELLA PIANA A FASCIA LARGA 6,6x18 UNI 6593	999-00-C0C-20618	
21	RONDELLA PIANA A FASCIA LARGA 11x40 UNI 6593	999-00-C0C-21140	
22	RONDELLA PIANA M20 ZN UNI 6592	999-00-C0C-10020	
23	SPINA A SCATTO Ø11x58	999-00-C0N-00005	
1 (100-00-A0Q-00002)			
24	LAMA TERZO PUNTO/PULEGGIE	100-00-P0A-00081	
25	INNESTO PER TRASMISSIONE TRE PUNTI	100-00-P0B-00194	
26	PULEGGIA POLY-V 8 GOLE (TIPO "J") Øe150	100-00-P0B-00196	
27	BOCCOLA CIL Øe22.0 Øi17.5 L=15	100-00-P0B-00188	
28	ALBERO SCANALATO PER TRASMISSIONE 3 PUNTI	100-00-P0B-00195	
29	CUSCINETTO 6003-2RS C3	999-00-CAC-00003	
30	GHIERA KM10 DIN 981	999-00-CAM-00001	
31	SEEGER PER FORI Ø35 UNI 7437	999-00-C0E-00002	

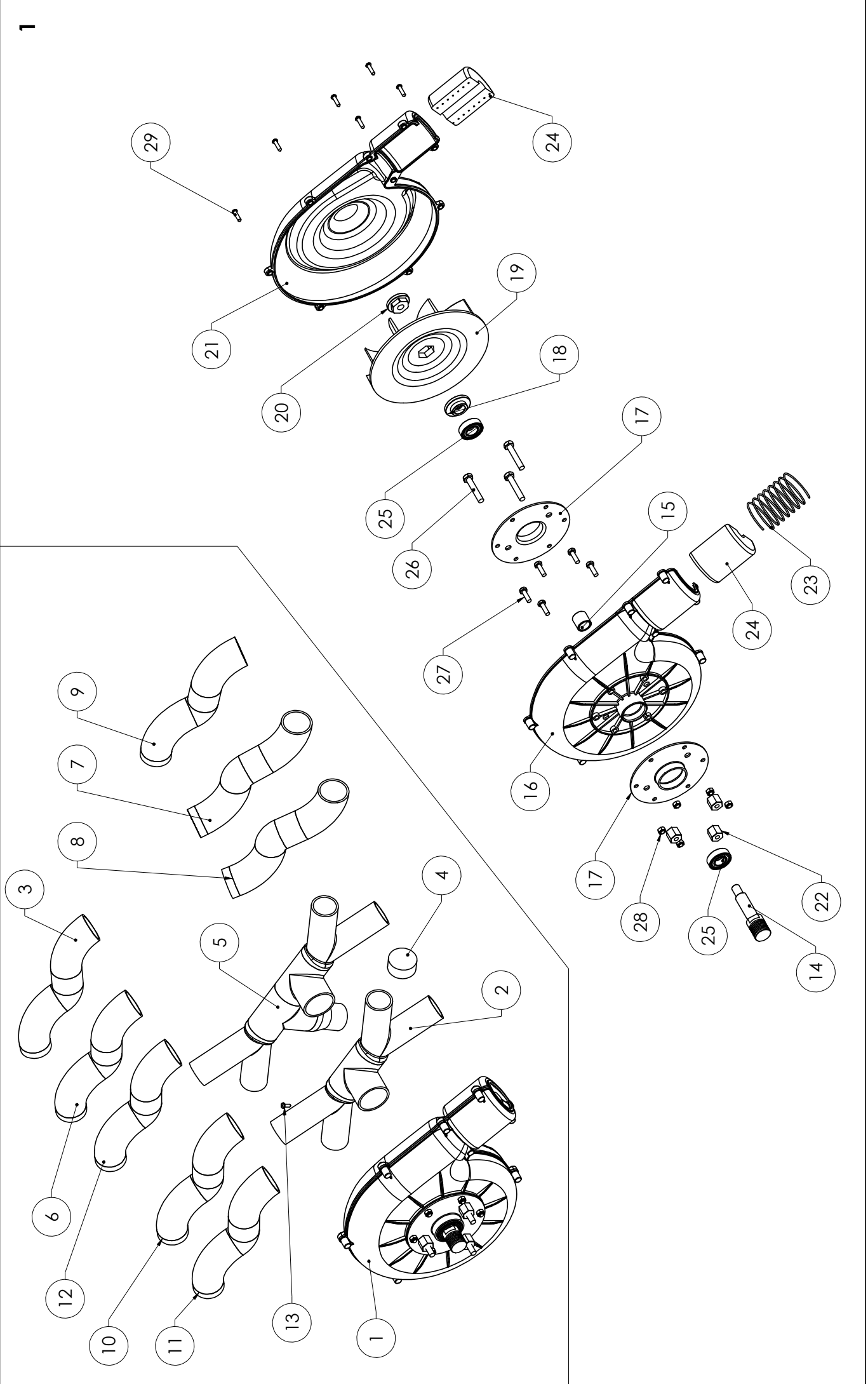



DEPRESSORE

RC-400-002

Rev. 00

RIF.	DESCRIZIONE	CODICE
1	ASSIEME DEPRESSORE WZ-D	100-00-A0F-00003
2	BRAGA Ø50-Ø40 4 USCITE	100-00-POC-00070
3	TUBO SPIRALATO CORDFLEX AIR/P Ø40 ANTI UV L=1150	100-00-POB-00375
4	TAPPO PE Ø40	999-00-CAI-00005
5	BRAGA Ø50-Ø40 5 USCITE	100-00-POC-00071
6	TUBO SPIRALATO CORDFLEX AIR/P Ø40 ANTI UV L=1200	100-00-POB-00377
7	TUBO SPIRALATO CORDFLEX AIR/P Ø40 ANTI UV L=1250	100-00-POB-00378
8	TUBO SPIRALATO CORDFLEX AIR/P Ø40 ANTI UV L=1350	100-00-POB-00380
9	TUBO SPIRALATO CORDFLEX AIR/P Ø40 ANTI UV L=1400	100-00-POB-00381
10	TUBO SPIRALATO CORDFLEX AIR/P Ø40 ANTI UV L=1800	100-00-POB-00385
11	TUBO SPIRALATO CORDFLEX AIR/P Ø40 ANTI UV L=2000	100-00-POB-00387
12	TUBO SPIRALATO CORDFLEX AIR/P Ø40 ANTI UV L=1500	100-00-POB-00382
13	VITE AUTOFIL. TCB M4,2x13 ZN UNI 6954	999-00-C0A-74213
1 (100-00-A0F-00003)		
14	ALBERO CON PULEGGIA POLY-V 8 GOLE (TIPO "J") Øe25 (TRATTORE)	100-00-POB-00220
15	BOCCOLA CIL. Øe22.0 Øi17.1 L=20.2	100-00-POB-00045
16	GUSCIO DEPRESSORE LATO MOTORE	100-00-P0D-00004
17	FLANGIA INTERNA/ESTERNA DEPRESSORE	100-00-P0A-00042
18	BOCCOLA DISTANZIALE GIRANTE	100-00-POB-00046
19	GIRANTE DEPRESSORE Ø190	100-00-P0D-00006
20	DADO ALBERO GIRANTE DEPRESSORE	100-00-POB-00047
21	GUSCIO DEPRESSORE CORTO LATO DISTRIBUTORE	100-00-POB-00285
22	DISTANZIALE ESAZIONALE	100-00-POB-00201
23	MOLLA FILO Ø2 Øe 54 L=78	100-00-C0F-00002
24	SPUGNA POLIESTIC BUGNATA AD. S.30	999-00-C0R-00001
25	CUSCINETTO 6003-2RS C3	999-00-CAC-00003
26	VITE TE M8x45 - 8.8 ZN UNI 5739	999-00-C0A-20845
27	VITE TE M6x20 - 8.8 ZN UNI 5739	999-00-C0A-20620
28	DADO ESAZIONALE AUTOBLOCCANTE M6 ZN DIN 980	999-00-C0B-60006
29	VITE AUTOFIL. TCB M4,8x19 ZN UNI 6954	999-00-C0A-74819

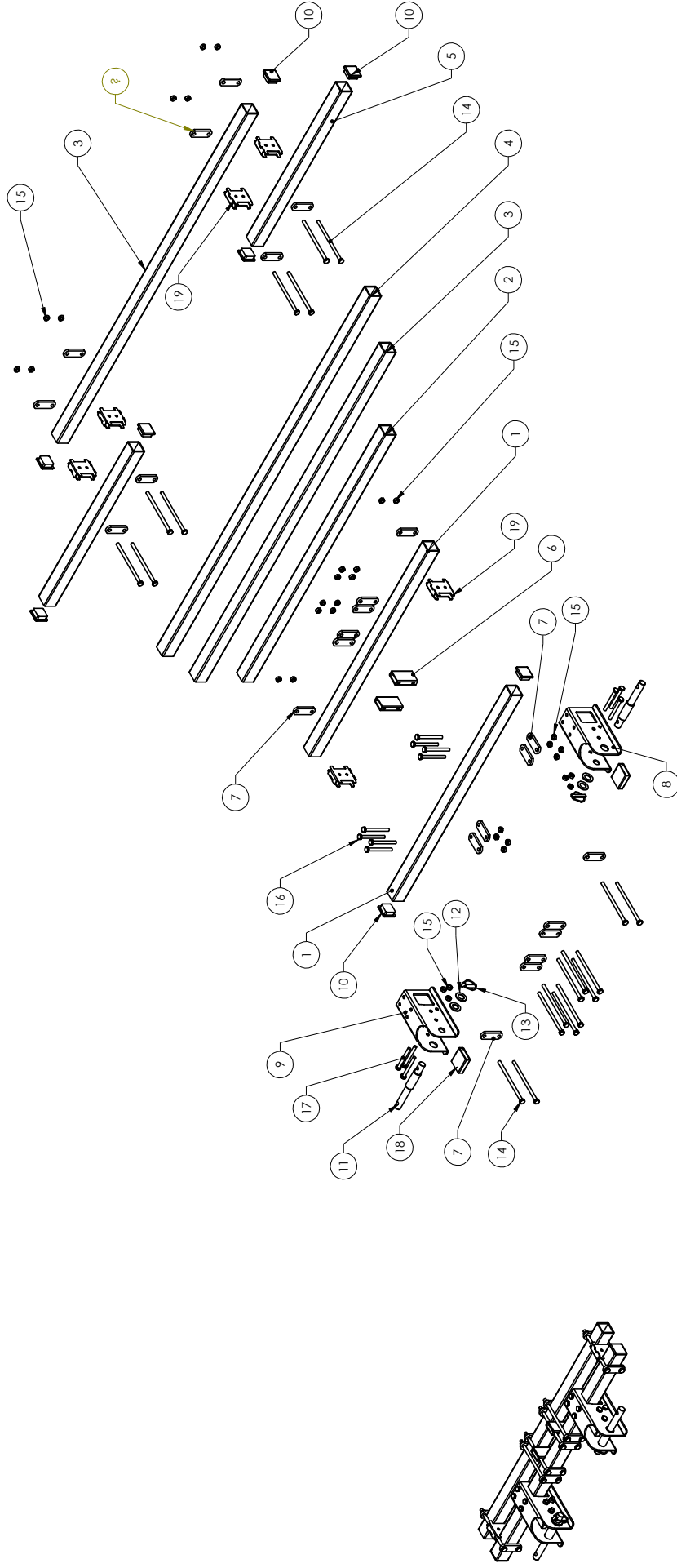
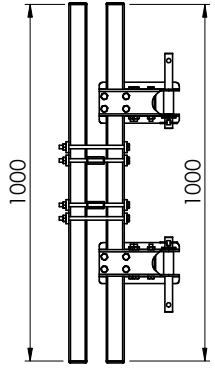
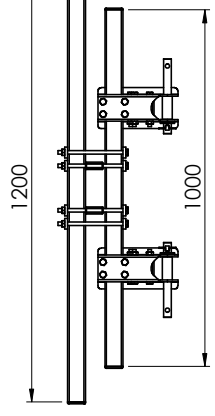
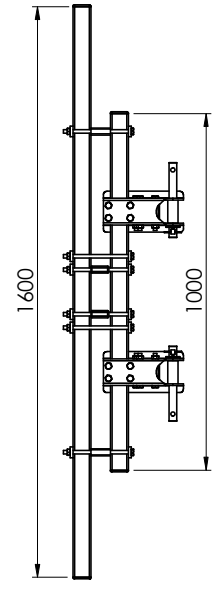
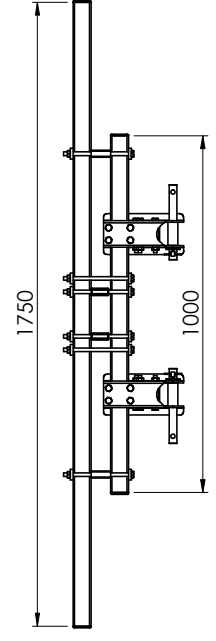
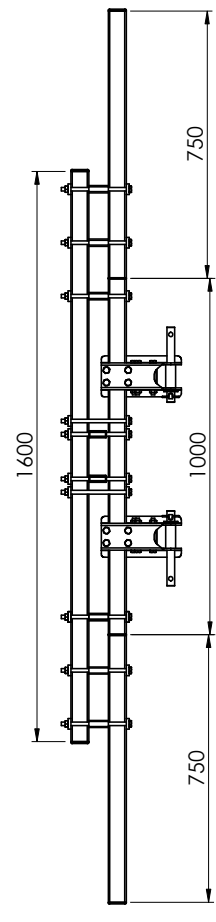
A

B

C

D

E



TELAIO

RC-400-003

Rev. 00

RIF.	DESCRIZIONE	CODICE
1	TUBO 50x50x4 L=1000	100-00-POB-00115
2	TUBO 50x50x4 L=1200	100-00-POB-00117
3	TUBO 50x50x4 L=1600	100-00-POB-00119
4	TUBO 50x50x4 L=1750	100-00-POB-00121
5	TUBO 50x50x4 L=750	100-00-POB-00113
6	DISTANZIALE	100-00-POB-00204
7	SCONTRO	100-00-POB-00005
8	LAMIERA 1° e 2° PUNTO SX	100-00-POA-00085
9	LAMIERA 1° e 2° PUNTO DX	100-00-POA-00093
10	TAPPO PER TUBO QUADRO (50x50)	999-00-CAI-00001
11	PERNO DOPIO ATTACCO ATTREZZI 1°-2° PUNTO CAT.1°-CAT.2°	999-00-COO-02228
12	RONDELLA PIANA M22 ZN UNI 6592	999-00-COC-10022
13	SPINA A SCATTO Ø11x58	999-00-CON-00005
14	VITE TE M10x190 - 8.8 ZN UNI 5739	999-00-COA-91319
15	DADO ESA GONIALE M10 ZN UNI 5588	999-00-COB-10010
16	VITE TE M10x100 - 8.8 ZN UNI 5737	999-00-COA-91310
17	VITE TE M10x90 - 8.8 ZN UNI 5737	999-00-COA-11090
18	TUBO 60x20x3 L=64	100-00-POB-00345
19	DISTANZIALE TUBO 50-50 DIST. 55	100-00-POC-00105

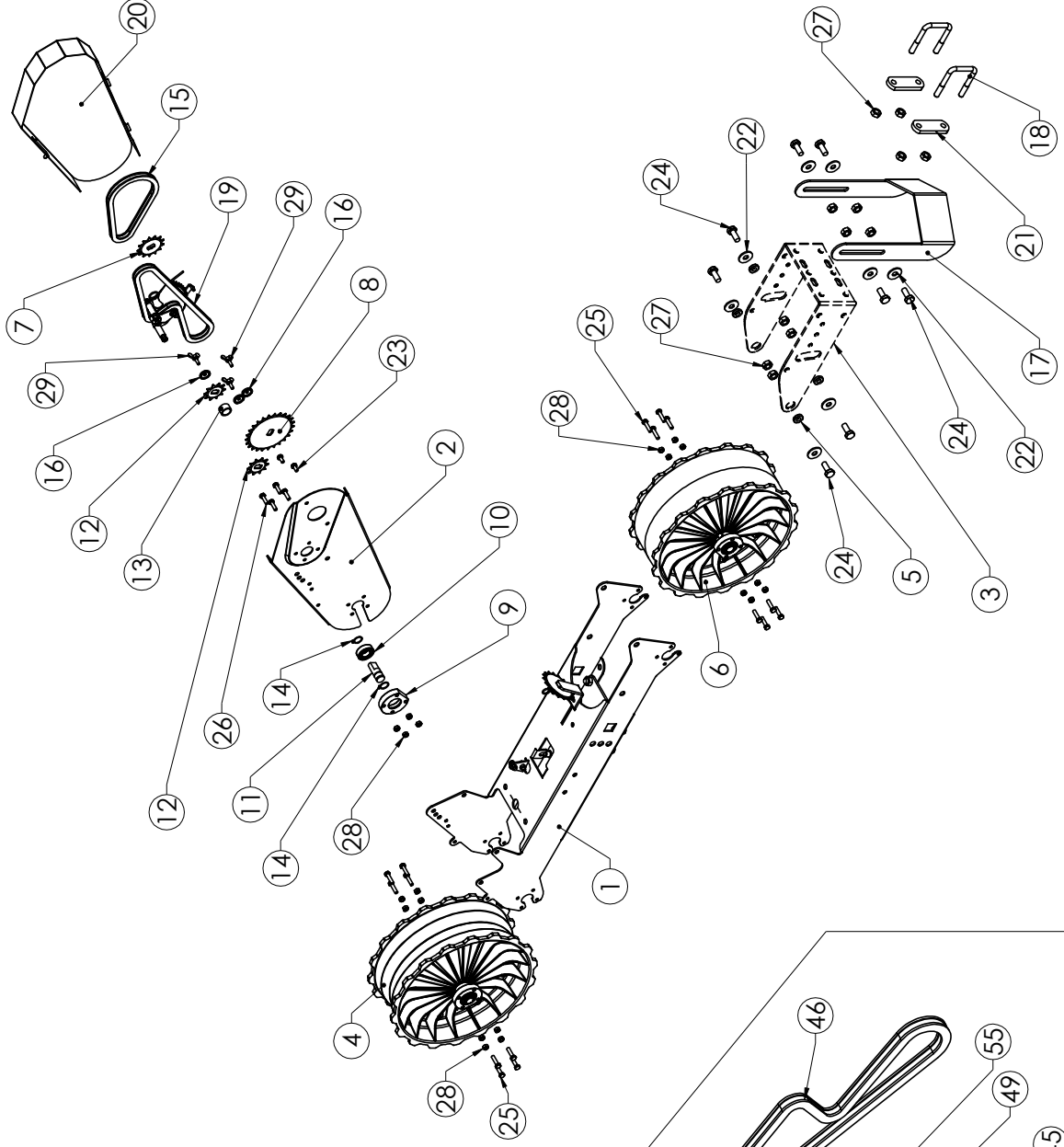
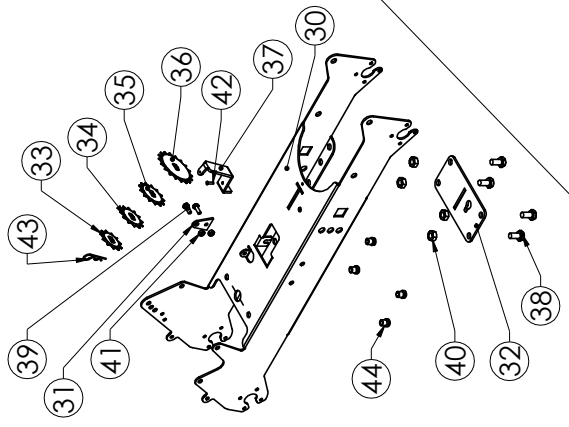
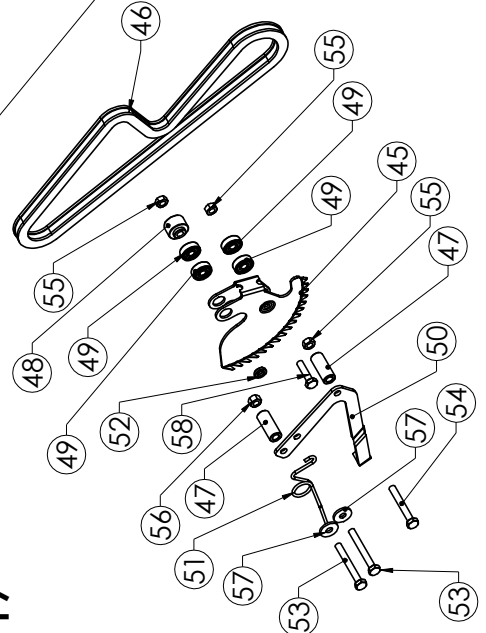
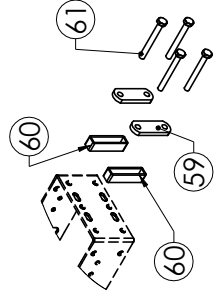
1

19

**PER INTERFILA
30-35-40cm**



ELEMENTO DI SEMINA 1050

RC-400-004

Rev. 00

RIF.	DESCRIZIONE	CODICE	1 (100-00-A0C-00003)	
1	TELAIO ELEMENTO DI SEMINA 1050	100-00-A0C-00003	34 CORONA 1/2" x 1/8" Z12 100-00-P0B-00076	
2	CARTER CAMBIO	100-00-P0A-00073	35 CORONA 1/2" x 1/8" Z13 100-00-P0B-00077	
3	LAMIERA ATTACCO TELAI0 ELEMENTO 1050	100-00-P0A-00056	36 CORONA 1/2" x 1/8" Z18 100-00-P0B-00078	
4	MONTAGGIO RUOTA DI COMPRESSIONE	100-00-A0B-00003	37 STAFFA SUPPORTO INGRANAGGI 100-00-P0A-00071	
5	BOCCOLA CIL Øe20.0 Øi10.0 L=5.0	100-00-P0B-00055	38 VITE TE M10x20 - 8.8 ZN UNI 5739 999-00-C0A-21020	
6	MONTAGGIO RUOTA CONDOTTA	100-00-A0B-00006	39 VITE TE M6x16 - 8.8 ZN UNI 5739 999-00-C0A-20616	
7	CORONA 1/2" x 1/8" Z13	100-00-P0B-00077	40 DADO ESAGONALE M10 ZN UNI 5588 999-00-C0B-10010	
8	CORONA 1/2" x 1/8" Z25	100-00-P0B-00079	41 DADO ESAGONALE M6 ZN UNI 5588 999-00-C0B-10006	
9	SUPPORTO CUSCINETTI Ø35	100-00-P0B-00061	42 RIVETTO A STRAPPO D3.4x14 999-00-C0T-00001	
10	CUSCINETTO 6003-2RS	999-00-CAC-00001	43 COPIGLIA UNI 8833-A 3.2 999-00-C0S-00002	
11	ASSE RUOTA DENTATA	100-00-P0B-00020	44 INSERTO FILETTATO M8 CON COLLARE ZIGRINATO 999-00-C0H-00002	
12	CORONA 1/2" x 1/8" Z10	100-00-P0B-00074	19 (100-00-A0E-00002)	
13	BOCCOLA CIL Øe22.0 Øi17.2 L=12.5	100-00-P0B-00019	45 SETTORE DENTATO TENDI CATENA 100-00-P0A-00030	
14	ANELLO ELASTICO PER ALBERI UNI 7435 Ø17	999-00-C0E-00001	46 CATENA A RULLI 1/2"x1/8" 62 PASSI L=787 100-00-P0B-00143	
15	CATENA A RULLI 1/2"x1/8" 36 Passi L=457	100-00-P0B-00140	47 BOCCOLA CIL Øe12.0 Øi6.5 L=30.25 100-00-P0B-00018	
16	RONDELLA BLOCCAGGIO CORONA	100-00-P0B-00012	48 BOCCOLA SCL Øe20.0 Øi6.5 L=15.25 SCL3.0 Ø12.0 100-00-P0B-00017	
17	SPARTIZOLLE	100-00-P0A-00065	49 CUSCINETTO 626-2RS 999-00-CAC-00002	
18	50x50 CAVALLOTTO M10x51x72 /30 ZNB (TYPE 102)	100-00-CAP-00001	50 SUPPORTO TENDICATENA A SETTORE DENTATO 100-00-P0A-00031	
19	MONTAGGIO TENDICATENA	100-00-A0E-00002	51 MOLLA A TORSIONE SETTORE CAMBIO 100-00-C0F-00003	
20	CARTER PROTEZIONE CAMBIO	100-00-P0C-00035	52 DISTANZIALE Øe 12 x Øi 6.5 100-00-P0B-00056	
21	SCONTRO	100-00-P0B-00005	53 VITE TE M6x50 - 8.8 ZN UNI 5737 999-00-C0A-10650	
22	RONDELLA PIANA A FASCIA LARGA 11x30 UNI 6593	999-00-C0C-21130	54 VITE TE M6x45 - 8.8 ZN UNI 5737 999-00-C0A-10645	
23	VITE TE M6x12 - 8.8 ZN UNI 5739	999-00-C0A-20612	55 DADO ESAGONALE M6 ZN UNI 5588 999-00-C0B-10006	
24	VITE TE M10x25 - 8.8 ZN UNI 5739	999-00-C0A-21025	56 DADO ESAGONALE ALTO M6 UNI 5587 999-00-C0B-20006	
25	VITE TE M6x25 - 8.8 ZN UNI 5739	999-00-C0A-20625	57 RONDELLA PIANA A FASCIA LARGA 6.6x18 UNI 6593 999-00-C0C-20618	
26	VITE TE M6x20 - 8.8 ZN UNI 5739	999-00-C0A-20620	58 VITE TE M6x25 - 8.8 ZN UNI 5739 999-00-C0A-20625	
27	DADO ESAGONALE M10 ZN UNI 5588	999-00-C0B-10010	PER INTERFILIA 30-35-40cm	
28	DADO ESAGONALE M6 ZN UNI 5588	999-00-C0B-10006	59 SCONTRO 100-00-P0B-00005	
29	VITE AD ALETTE M5x16 UNI 5449	999-00-C0A-01002	60 TUBO 80x20x3 L=20 100-00-P0B-00347	
30	TELAIO ELEMENTO DI SEMINA 1050	100-00-P0A-00070	61 VITE TE M10x90 - 8.8 ZN UNI 5737 999-00-C0A-11090	
31	LAMIERA DISTANZIALE DISTRIBUTORE	100-00-P0A-00017		
32	LAMIERA RINFORZO FALCIONE	100-00-P0A-00074		
33	CORONA 1/2" x 1/8" Z11	100-00-P0B-00075		

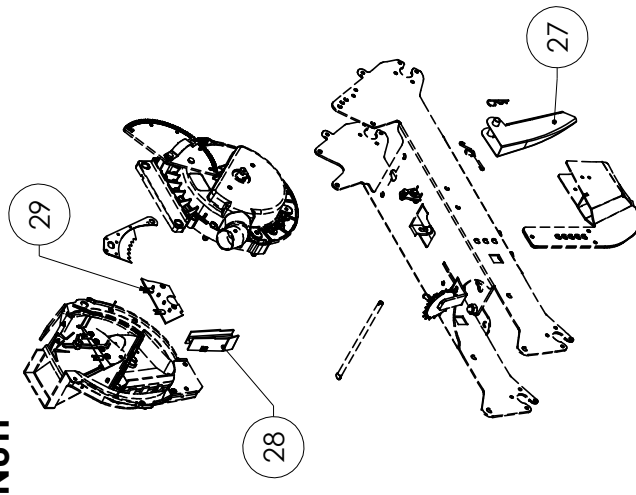
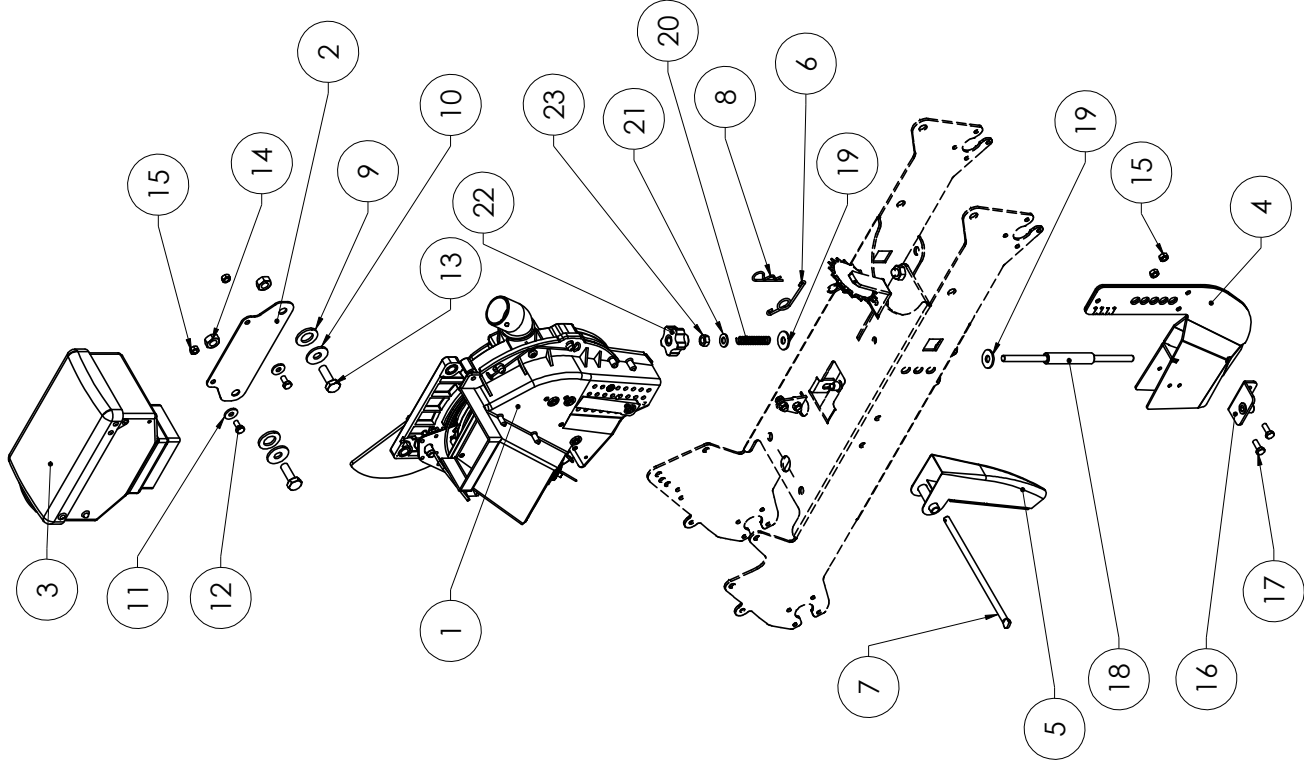
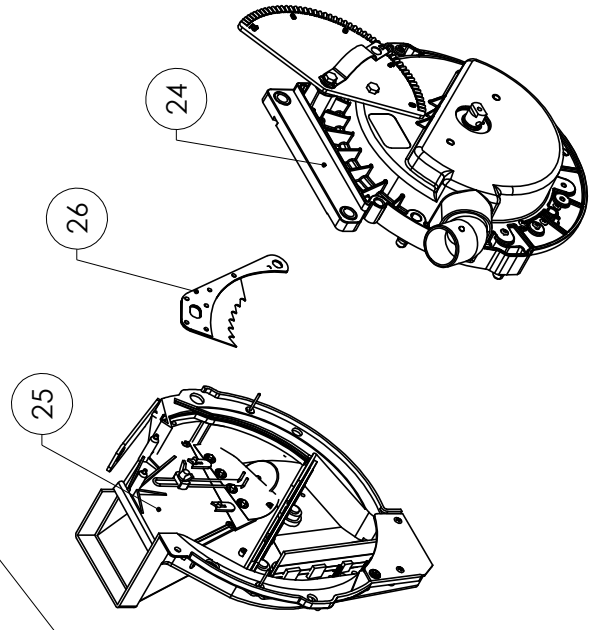
KIT SEMI MINUTI**1**



DISTRIBUZIONE

RC-400-005

Rev. 00

RIF.	DESCRIZIONE	CODICE
1	MONTAGGIO DISTRIBUTORE SEMINA	100-00-COU-00000
2	SUPPORTO SERBATOIO	100-00-POA-00099
3	SERBATOIO SEMI 5 lt	100-00-A0A-00002
4	FALCIONE	100-00-P0C-00036
5	TUBO CADUTA SEMI GROSSI (Per elemento)	100-00-P0C-00037
6	MOLLA TUBO DISCESA SEMI	100-00-C0F-00004
7	SPINA CHIAVISTELLO	100-00-P0B-00099
8	COPIGLIA UNI 8833-A 3.2	999-00-C0S-00002
9	RONDELLA PIANA M16 ZN UNI 6592	999-00-C0C-00016
10	RONDELLA PIANA A FASCIA LARGA 11x30 UNI 6593	999-00-C0C-21130
11	RONDELLA PIANA A FASCIA LARGA 6,6x18 UNI 6593	999-00-C0C-20618
12	VITE TE M6x12 - 8.8 ZN UNI 5739	999-00-C0A-20612
13	VITE TE M10x30 - 8.8 ZN UNI 5739	999-00-C0A-21030
14	DADO ESAGONALE M10 ZN UNI 5588	999-00-C0B-10010
15	DADO ESAGONALE M6 ZN UNI 5588	999-00-C0B-10006
16	LAM. REG. A VITE CON INSERTO	100-00-P0C-00110
17	VITE TE M6x16 - 8.8 ZN UNI 5739	999-00-C0A-20616
18	ASSE REGOLAZIONE PROFONDATA' A VITE	100-00-P0B-00400
19	RONDELLA PIANA A FASCIA LARGA 9x24 UNI 6593	999-00-C0C-20924
20	MOLLA COMPRESSIONE FILO Ø1.0 Øe 10.5 L 50	100-00-C0F-00010
21	RONDELLA PIANA M8 ZN UNI 6592	999-00-C0C-10008
22	VOLANTINO A LOBI VCT-AZ RA19005	999-00-CAV-00005
23	DADO ESAGONALE M8 ZN UNI 5588	999-00-C0B-10008
1 (100-00-COU-00000)		
24	CORPO DISTRIBUTORE	100-00-COU-00001
25	COPERCHIO DISTRIBUTORE	100-00-COU-00002
26	SELETTORE MAGICSEM STANDARD PER PISTONCINO	100-00-COU-00005
KIT SEMI MINUTI (100-00-VVV-00000)		
27	TUBO CADUTA SEMI PICCOLI (per elemento)	100-00-P0C-00038
28	GUIDA SEMI SINGOLA	100-00-COU-00007
29	PROLUNGA DIVISORE COPERCHIO	100-00-COU-00006

Via delle Industrie, 19—33098 Valvasone Arzene (PN)

tel: +39 0434 871461

e-mail: info@wizardagroind.eu

P.Iva: 01781020936

