



Flex Tine Mount Kit Installation AA-9020



Go to www.tilmor.com/resources for complete parts list, additional resources and replacement part ordering.

Release Date: 11/28/2018
Document Number: 12-70003
Revision Number: 00

ATTENTION
Review safety information before operation.

 Tools
3/4" wrench 3/4" socket Ratchet Torque wrench

Installation Time (estimated) *10 minutes*

REQUIRED PARTS

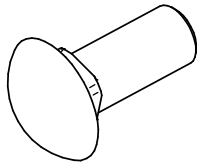
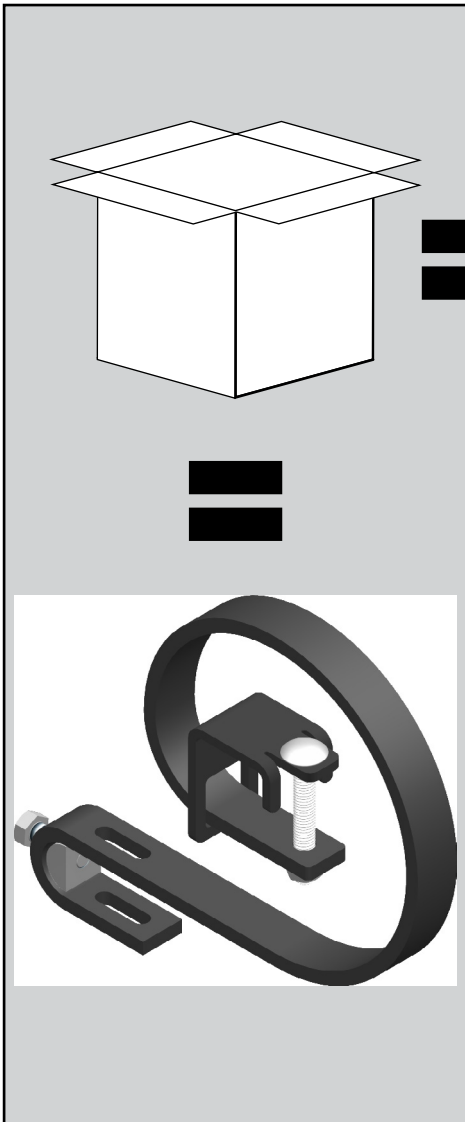

1x
97-0828
1/2" Carriage Bolt

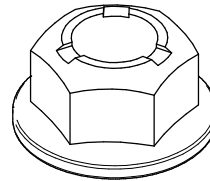

1x
99-SF08
1/2" Flange Nut

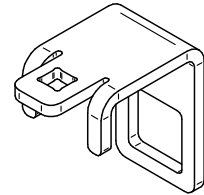

1x
AA-3009
Bracket, Flex Tine
Mount

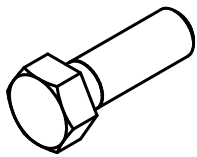

1x
91-0812
1/2" Hex Bolt

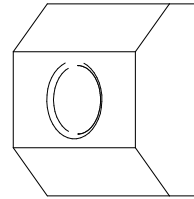

1x
AA-3004
1/2" Nut, Half
Round

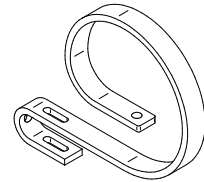

1x
AA-3008
Mount, Flex Tine

ASSEMBLY

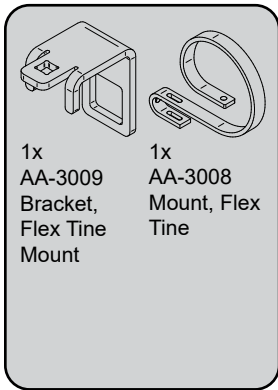

1x
AA-3009
Bracket,
Flex Tine
Mount

1x
AA-3008
Mount, Flex
Tine

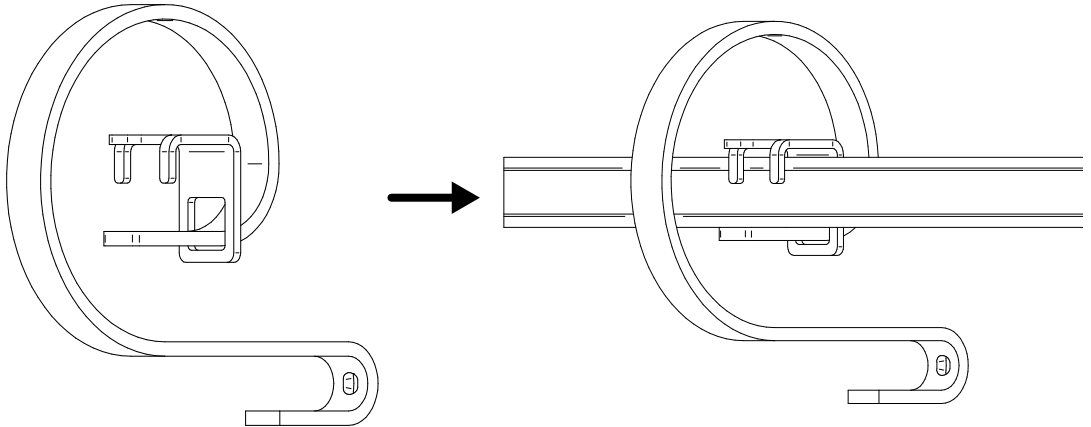

1



3/4" Socket, Torque Wrench

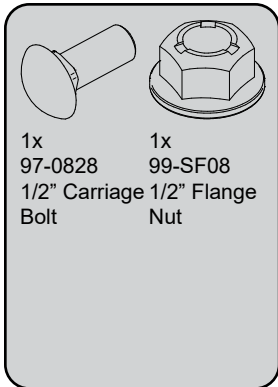

1x
97-0828
1/2" Carriage
Bolt

1x
99-SF08
1/2" Flange
Nut

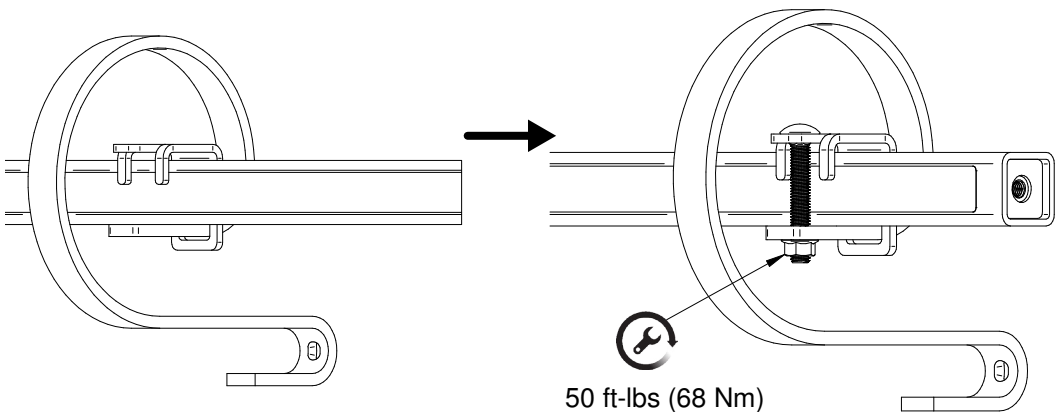

50 ft-lbs (68 Nm)

2



3/4" Socket, Ratchet

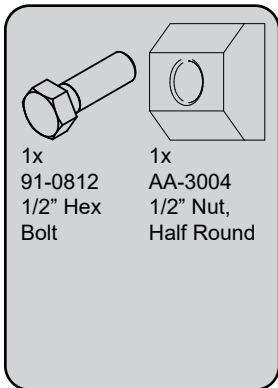

1x
91-0812
1/2" Hex
Bolt

1x
AA-3004
1/2" Nut,
Half Round

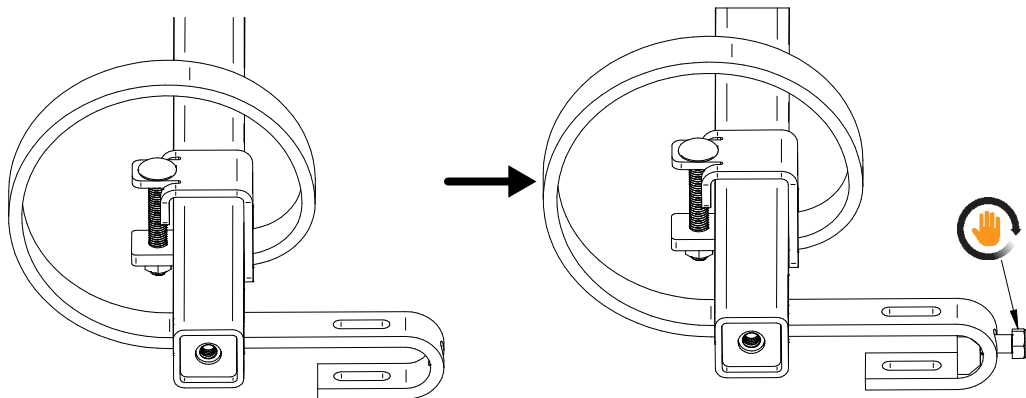

3



The 1/2" hex bolts should be installed hand tight. When a shank is installed through the flex tine the 1/2" flange bolts should be torqued to 90 ft-lbs (122 Nm) to hold the shank in place.