



# 13" Finger Weeder Assembly AW-9003

Go to [www.tilmor.com/resources](http://www.tilmor.com/resources) for complete parts list, additional resources and replacement part ordering.

Release Date: 07/16/2019  
Document Number: 12.70038  
Revision Number: 00

**ATTENTION**  
Review safety information before operation.

Tools	
	1/2" Socket 9/16" Socket Drive Extension Torque Wrench

**Installation Time (estimated)** 15 minutes

## REQUIRED PARTS

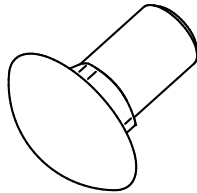
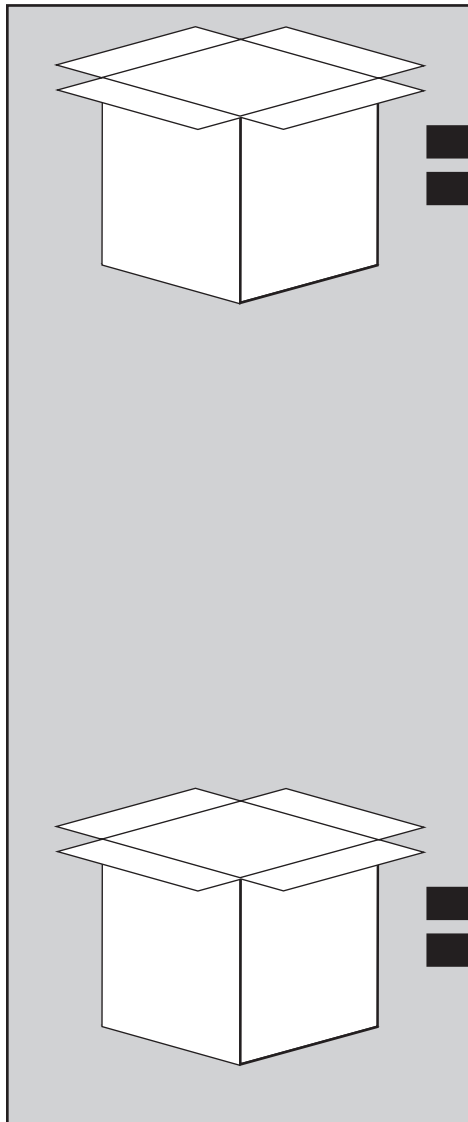

4x  
Bolt, Carriage  
5/16" x 1-1/4"  
97.0510

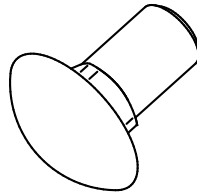

2x  
Bolt, Carriage  
3/8" x 1"  
97.0608

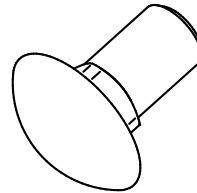

2x  
Bolt, Carriage  
3/8" x 2-1/4"  
97.0618

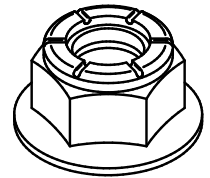

4x  
Nut, Locking  
Flange 5/16"  
99.E0102

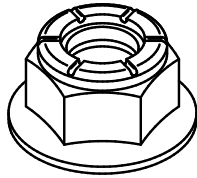

2x  
Nut, Locking  
Flange 3/8"  
99.E0082

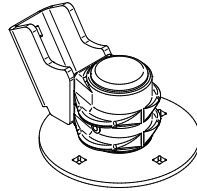

1x  
Hub Assembly

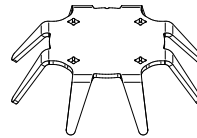

1x  
Drive Plate  
AW-1033

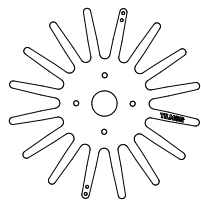

1x  
Finger, Medium 13"  
(Yellow)  
AW-3011

OR

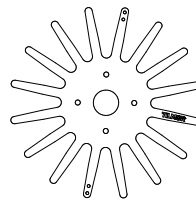

1x  
Finger, Hard 13"  
(Black)  
AW-3012

# ASSEMBLY

 1/2" Socket, Drive Extension, Torque Wrench

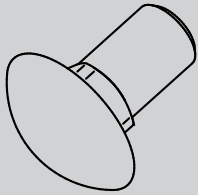

4x  
Bolt, Carriage  
5/16" x 1-1/4"  
97.0510

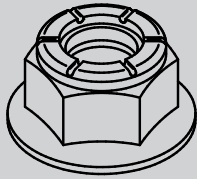

8x  
Nut, Locking  
Flange 5/16"  
99.E0102

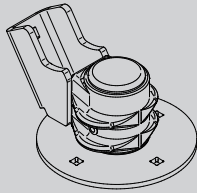

1x  
Hub Assembly

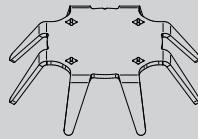

1x  
Drive Plate  
AW-1033

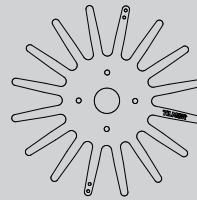

1x  
Finger, Medium 13"  
(Yellow)  
AW-3011

OR

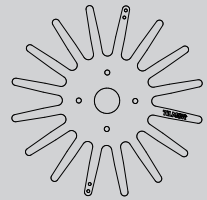

1x  
Finger, Hard 13"  
(Black)  
AW-3012

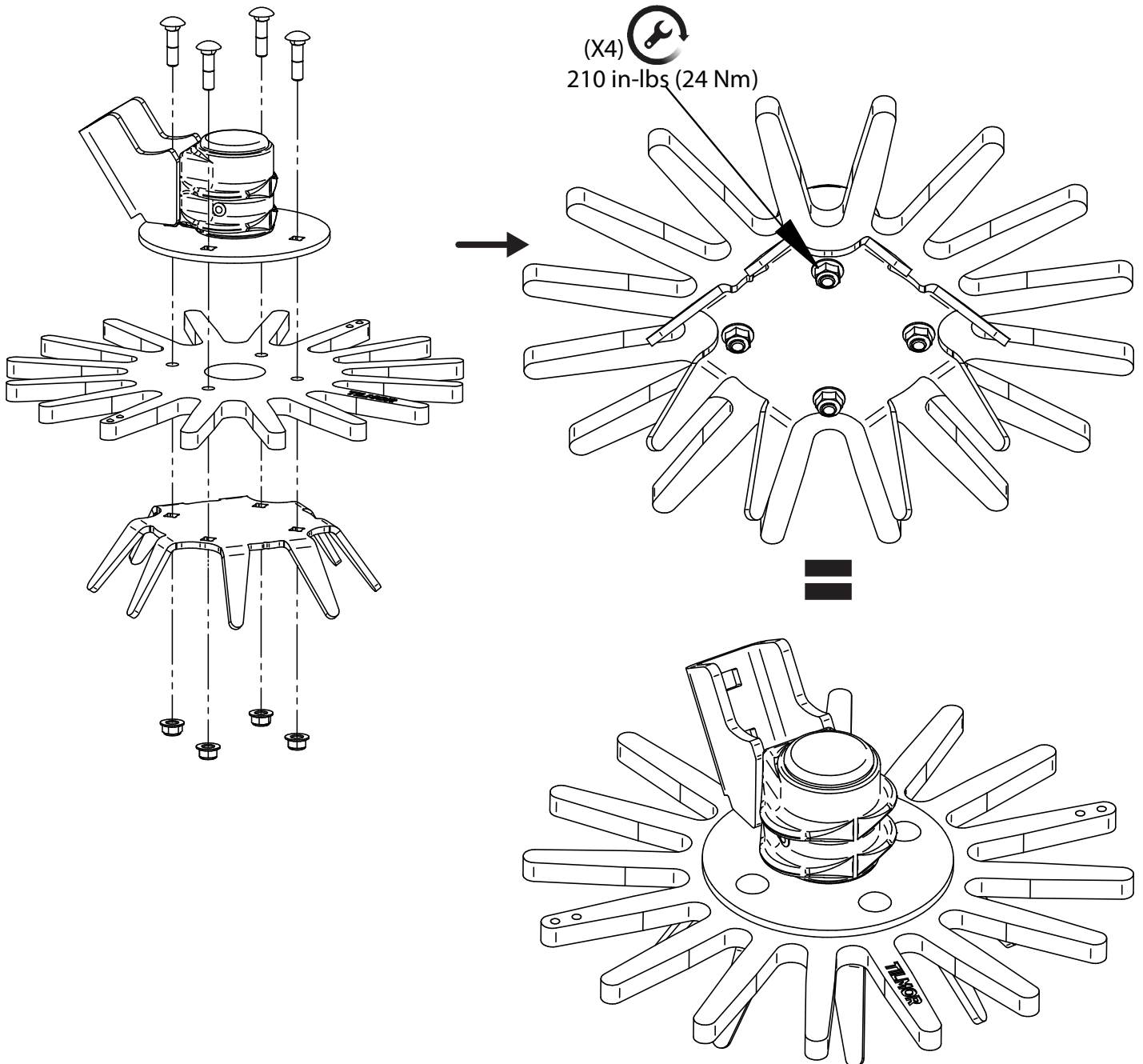

# INSTALLATION ON FLAT SHANK

 9/16" Socket, Torque Wrench

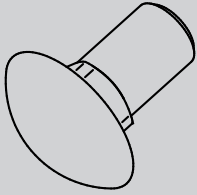

2x  
Bolt, Carriage  
3/8" x 1"  
97.0608

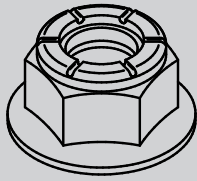

2x  
Nut, Locking  
Flange 3/8"  
99.E0082

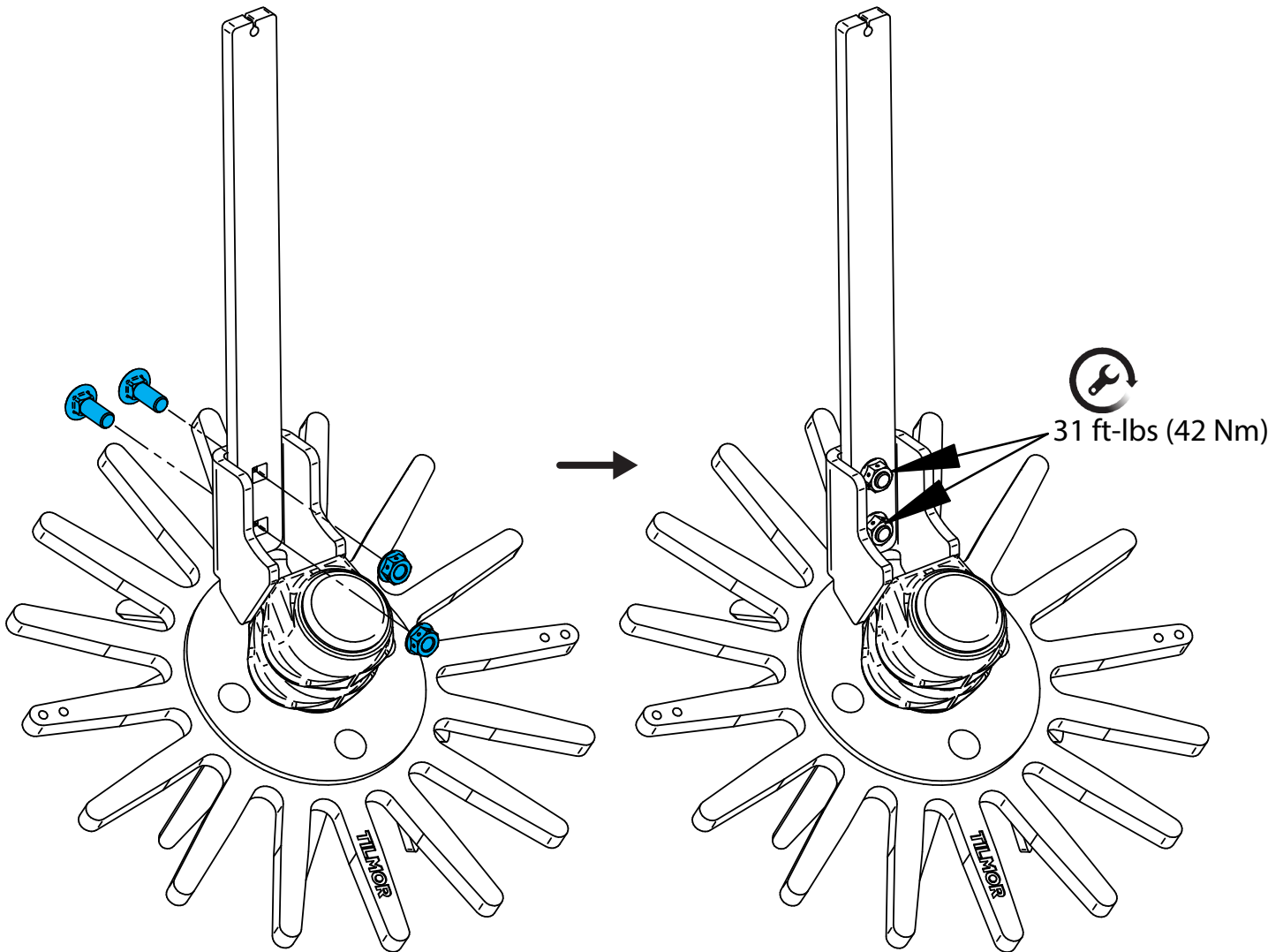

# INSTALLATION ON MODBAR

 9/16" Socket, Torque Wrench

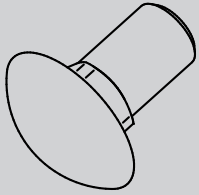

2x  
Bolt, Carriage  
3/8" x 2-1/4"  
97.0618

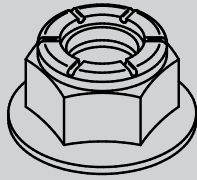

2x  
Nut, Locking  
Flange 3/8"  
99.E0082

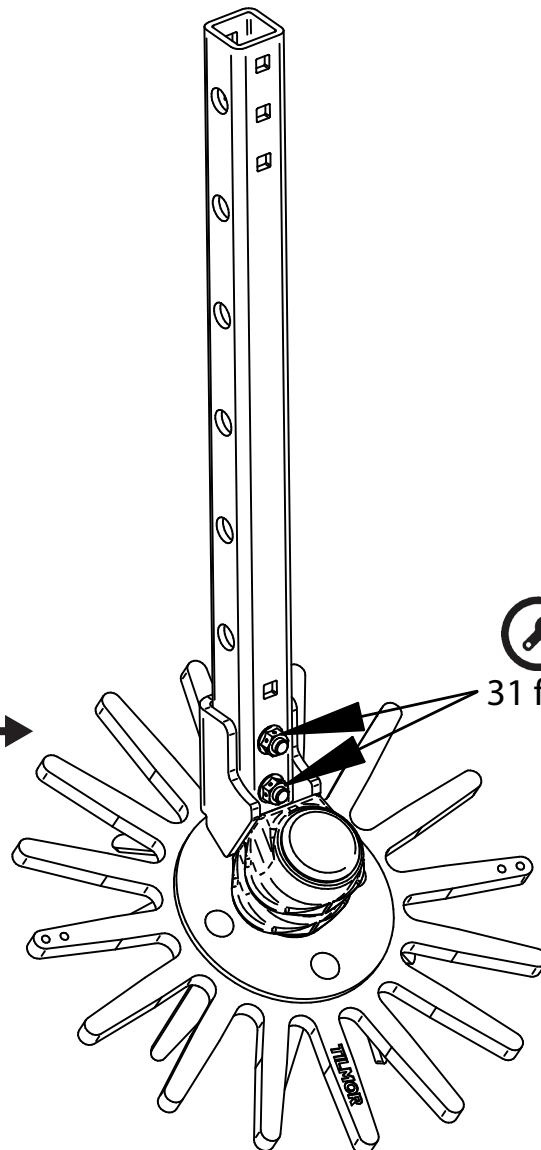
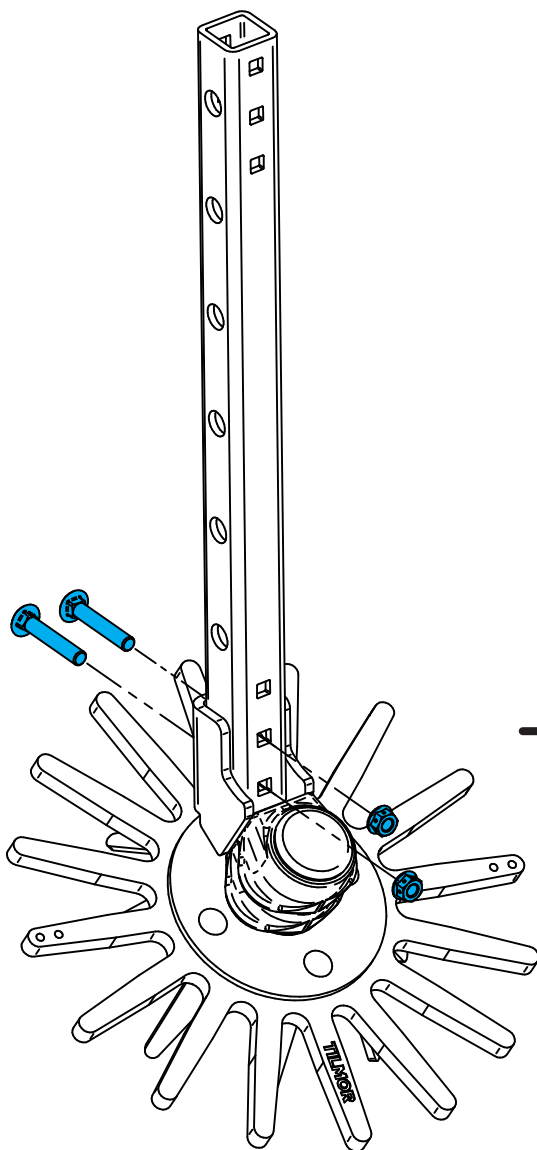

31 ft-lbs (42 Nm)