

Go to [www.tilmor.com/resources](http://www.tilmor.com/resources) for complete parts list, additional resources and replacement part ordering.



**ATTENTION**

Review safety information before operation.



**TOOLS**

**Required:**

9/16" Wrench

**Recommended:**

Impact Wrench

Measuring Tape

## TOOLBAR ASSEMBLY



9/16" WRENCH OR SOCKET

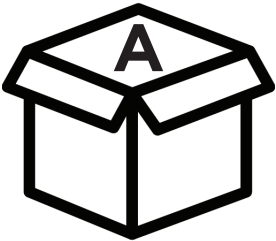

=

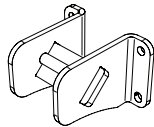

**2x**  
AA-6016

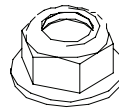

**8x**  
99.E0082  
3/8-16 Locking Flange

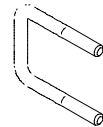

**4x**  
11.0053

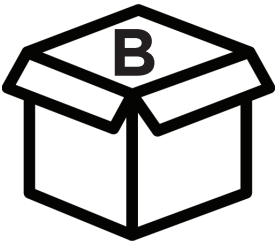

=

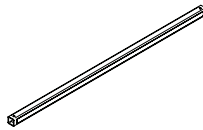

**1x**  
2" Square Toolbar:  
49.4101/49.4102  
or user supplied

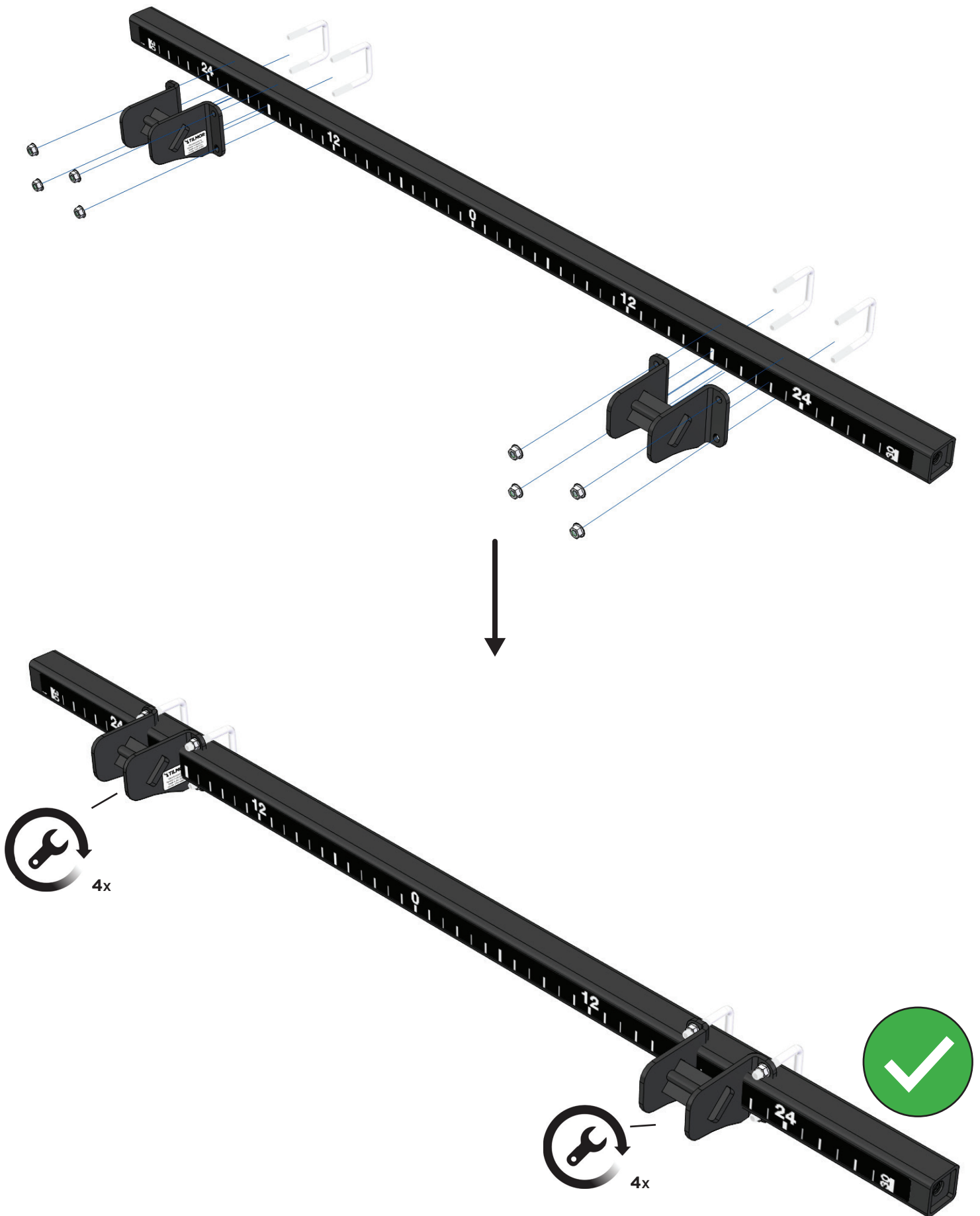

ATTENTION: Review safety information before operation.

ATTENTION: Examiner les consignes de sécurité avant l'utilisation.

ADVERTENCIA: Revisar la información de seguridad antes de la operación.

## WARRANTY

Unless otherwise stated, all non-serialized Tilmor products are protected against defects in materials and workmanship, under ordinary and normal use, for a period of one year from the shipping date. Under the terms of the warranty, Tilmor may opt to repair, replace, or issue a refund for products that are defective or have sustained damage in shipping. Replacement of products or parts subject to normal wear and tear is the responsibility of the customer. If Tilmor chooses to accept a return under warranty, you may return the defective or damaged product only after you call and receive a Return Merchandise Authorization (RMA) from Tilmor. Warranties on non-serialized Tilmor products are non-transferable.

## ON FARM TRIAL

We want you to be completely satisfied with your Tilmor purchase. If for any reason you are not satisfied with your purchase, you may return non-serialized Tilmor branded equipment within 90 days of the original ship date. If returning an item, you will first need to contact a Tilmor customer support representative at 1-844-255-5864 to obtain a return merchandise authorization (RMA) prior to shipping the item to Tilmor. Shipping costs for returns will be incurred by the customer. After receiving the returned item, an exchange or full refund of the product's original price will be given, less shipping charges to and from the delivery address. All new and unused products may be returned within 30 days of the ship date for a full refund. For more information, please call 1-844-255-5864.

## LEGAL NOTICES

Venture Products Inc. reserves the right to make changes in design or specifications without incurring obligation to make like changes on previously manufactured products.



Copyright © 2017 Venture Products, Inc.  
All rights reserved.

**1-844-255-5864**

Tilmor, 500 Venture Drive. Orrville, OH 44667

[www.tilmor.com](http://www.tilmor.com)